

1x

1x

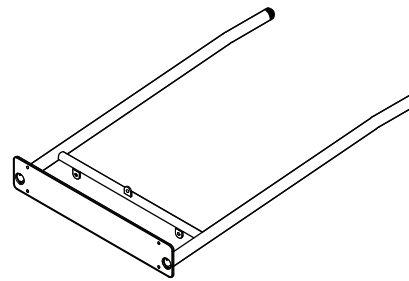

2x

1

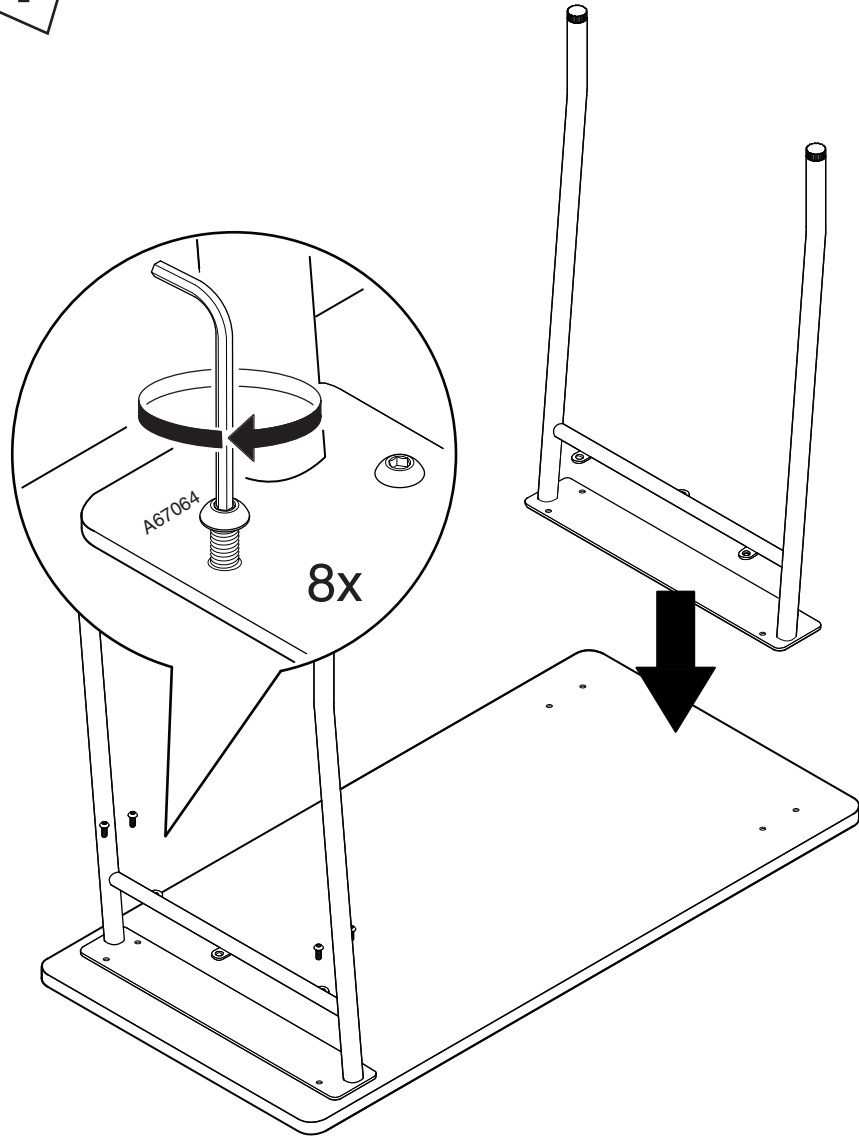

2

